



ALLEGION™



CISA®

CISA Safe Home

Locks for shutters
and security grates



Find out more at:
cisacasasicura.com

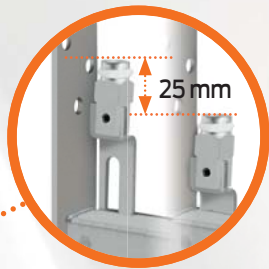

**EXTENDED BOLT
STROKE 25 MM**

The extended bolts are capable of a stroke of 25 mm and engage deeper in the frame

BENEFIT:

- Increased security against lifting the door



GRADE 3 SECURITY



**STAINLESS STEEL
FACEPLATE**

**EXTENDED BOLTS ARE
ALWAYS ENGAGED**

If force is applied to the dead-bolt to attempt entry, the extended bolts remain engaged

BENEFIT:

- Increased security against break-ins

Cylinder locks
for security
grates





Cylinder locks for shutters

EXTENDED BOLT STROKE 25 MM

The extended bolts are capable of a stroke of 25 mm and engage deeper in the frame

BENEFIT:

- Increased security against lifting the door

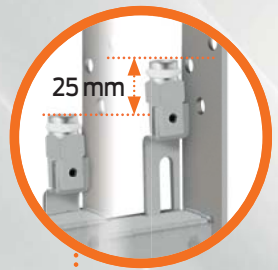

HANDLE FORCING

If an attempt is made to force the handle when it is deadlocked, the dead-bolt and the extended bolts are not withdrawn

BENEFIT:

- Increased security against any attempt of forcing the handle from outside

DEAD-BOLT LOCKING

By acting on the handle, the dead-bolt is deadlocked without using the key

BENEFIT:

- Increased security against break-ins

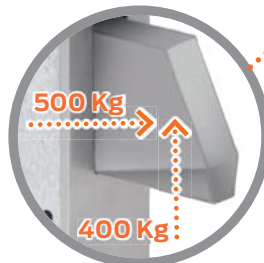

GRADE 3 SECURITY

EXTENDED BOLTS ARE ALWAYS ENGAGED

If force is applied to the dead-bolt to attempt entry, the extended bolts remain engaged

BENEFIT:

- Increased security against break-ins



STAINLESS STEEL FACEPLATE

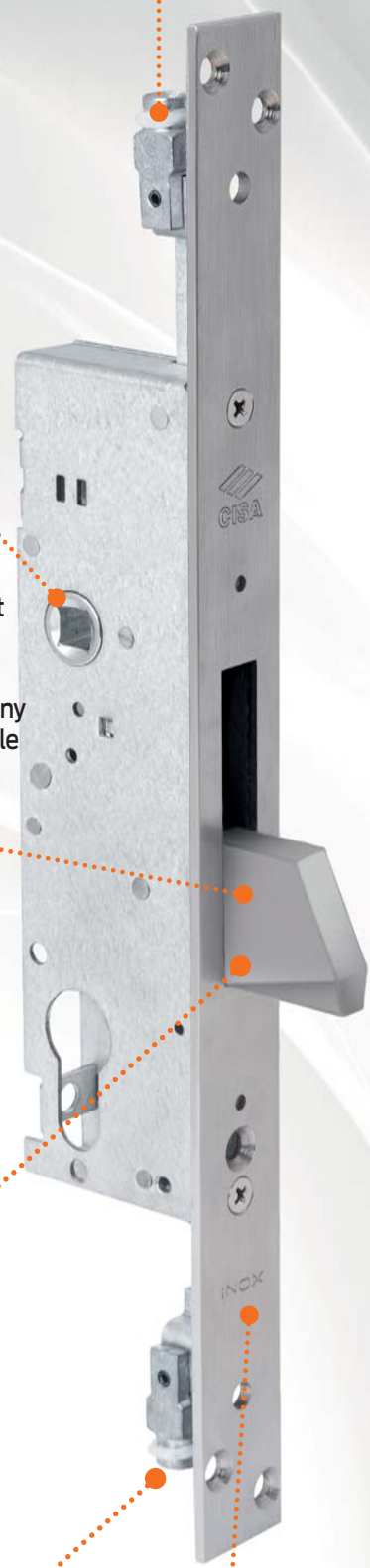

CYLINDER LOCKS FOR SHUTTERS

for metal frames



Technical features:

- 25 mm driving gears stroke
- Zinc-plated steel case
- STAINLESS steel faceplate
- 8 mm square spindle
- Chamfered dead-bolt to facilitate bolt engagement

Operation

The handle operates the swinging dead-bolt and the extended bolts, bringing them in the locking position; the key blocks the handle

Supplied as standard:

- Cylinder fixing screw
- Instruction sheet

Hand:



0 = non-handed

Certification

- This lock series is certified according to the European Standard EN 12209:03 grade 3 Security (500 Kg lateral force resistance, 400 Kg resistance to blows from below)
- Suitable for doors certified to EN 1627:2011 up to resistance class WK/RC 2

Suitable for doors certified to EN 1627:2011 up to resistance class WK/RC 2

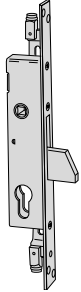

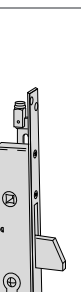

TYPE	DESCRIPTION	Throws	Centre distance	Faceplate	Backset	UNIT WEIGHT		ITEM				
						kg	NO. PIECES	Type	Dim.	Hand	Fin.	
 <ul style="list-style-type: none"> ▪ Nickel-plated dead-bolt ▪ Inside steel escutcheon item 1.06092.00.0 ▪ Pre-arranged for additional locking points with threaded bushings M8 <p>ON REQUEST:</p> <ul style="list-style-type: none"> ▪ Extended bolts item 1.07088.03.0 ▪ Cross-key cylinder item 1.02400.10.0 ▪ Floor striker item 1.06086.00.0 ▪ Floor striker with dust cover item 1.06086.02.0 ▪ Zinc-plated steel striking plate item 1.06232.21.0 	1	85	25	25	0.590	12	1	46800	25	0		
	1	85	25	30	0.610	12	1	46800	30	0		
	1	85	25	35	0.630	12	1	46800	35	0		
	1	85	25	25	0.590	12	1	46803	25	0		
	1	85	25	30	0.610	12	1	46803	30	0		
	1	85	25	35	0.630	12	1	46803	35	0		
 <ul style="list-style-type: none"> ▪ Nickel-plated dead-bolt ▪ Inside steel escutcheon item 1.06092.00.0 ▪ Pre-arranged for additional locking points with quick-lock bush system <p>ON REQUEST:</p> <ul style="list-style-type: none"> ▪ Quick-lock extended bolts item 1.07088.04.0.00.CG (without tips) ▪ Cross-key cylinder item 1.02400.10.0 ▪ Floor strike item 1.06086.00.0 ▪ Floor striker with dust cover item 1.06086.02.0 ▪ Zinc-plated steel striking plate item 1.06232.21.0 	1	85	25	25	0.710	12	1	46802	25	0		
	1	85	25	30	0.730	12	1	46802	30	0		
	1	85	25	35	0.750	12	1	46802	35	0		
	 <ul style="list-style-type: none"> ▪ Nickel-plated dead-bolt ▪ Cross-key cylinder with 3 keys ▪ Pair of nylon roses item 1.06002.00.0 ▪ Pre-arranged for additional locking points with threaded bushings M8 <p>ON REQUEST:</p> <ul style="list-style-type: none"> ▪ Extended bolts item 1.07088.03.0 ▪ Floor striker item 1.06086.00.0 ▪ Floor striker with dust cover item 1.06086.02.0 ▪ Zinc-plated steel striking plate item 1.06232.21.0 	1	85	25	25	0.710	12	1	46802	25	0	
		1	85	25	30	0.730	12	1	46802	30	0	
		1	85	25	35	0.750	12	1	46802	35	0	

CYLINDER LOCKS FOR SHUTTERS

for metal frames

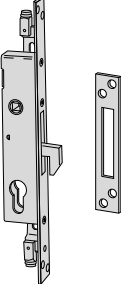

TYPE	DESCRIPTION	Throws	Centre distance	Faceplate	Backset	ITEM		ITEM			
						UNIT WEIGHT	NO. PIECES	Type	Dim.	Hand	Fin.
 <ul style="list-style-type: none"> Nickel-plated hook bolt, 7.5 mm Inside steel escutcheon item 1.06092.00.0 Zinc-plated steel striking plate item 1.06232.21.0 Pre-arranged for additional locking points with threaded bushings item M8 <p>ON REQUEST:</p> <ul style="list-style-type: none"> Extended bolts item 1.07088.03.0 Cross-key cylinder item 1.02400.10.0 Floor striker item 1.06086.00.0 Floor striker with dust cover item 1.06086.02.0 	1	85	25	25	0.650	12	1 46865	25	0		
	1	85	25	30	0.670	12	1 46865	30	0		
	1	85	25	35	0.690	12	1 46865	35	0		
 <ul style="list-style-type: none"> Top and bottom locking Inside steel escutcheon item 1.06092.00.0 Pre-arranged for additional locking points with threaded bushings M8 <p>ON REQUEST:</p> <ul style="list-style-type: none"> Extended bolts item 1.07088.03.0 Cross-key cylinder item 1.02400.10.0 Floor striker item 1.06086.00.0 Floor striker with dust cover item 1.06086.02.0 	85	25	25	0.570	12	1 46875	25	0			
	85	25	30	0.590	12	1 46875	30	0			
	85	25	35	0.620	12	1 46875	35	0			

Dimensional drawings

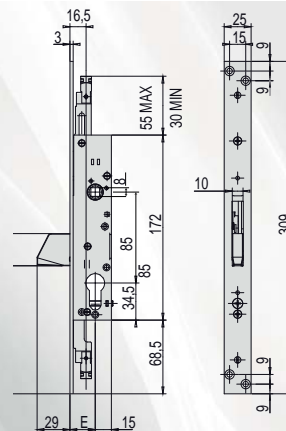

46800, 46802, 46820, 46822 (M8)
46803, 46823 (aggancio rapido)
 E = 25 - 30 - 35

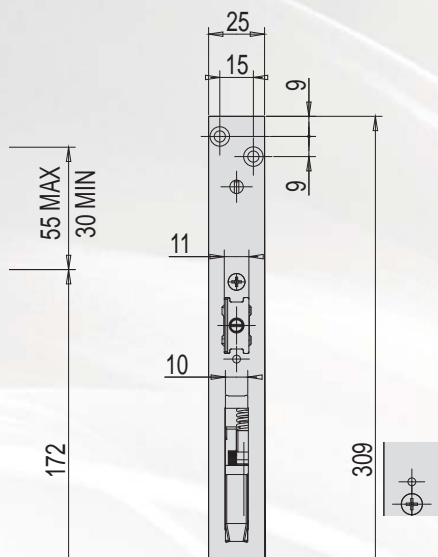

46860, 46865
 E = 25 - 30 - 35

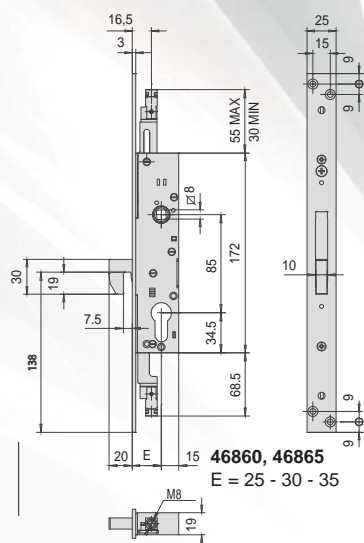

46870, 46875
 E = 25 - 30 - 35

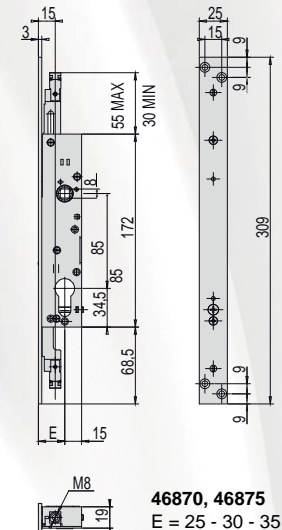

CYLINDER LOCKS FOR SECURITY GRATES

for metal frames





Technical features:
 25 mm driving gears stroke
 Zinc-plated steel case
 STAINLESS steel faceplate
 Chamfered dead-bolt to facilitate bolt engagement

Supplied as standard:

- Cylinder fixing screw
- Instruction sheet

On request:

- Cylinder protective rose item 1.06460.00.0

Hand:
 0 = non-handed

Certification

- This lock series is certified according to the European Standard EN 12209:03 grade 3 Security (500 Kg lateral force resistance, 400 Kg resistance to blows from below)
- Suitable for doors certified to EN 1627:2011 up to resistance class WK/RC 2

Cylinder to be ordered separately 

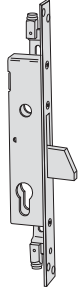
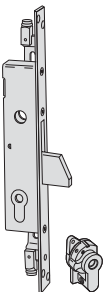
TYPE	DESCRIPTION	Throws	Centre distance	Faceplate	Backset	kg		ITEM			
						UNIT WEIGHT	NO. PIECES	Type	Dim.	Hand	Fin.
 <ul style="list-style-type: none"> ▪ Nickel-plated dead-bolt ▪ Inside steel escutcheon item 1.06092.00.0 ▪ Pre-arranged for additional locking points with threaded bushings M8 <p>ON REQUEST:</p> <ul style="list-style-type: none"> ▪ Extended bolts item 1.07088.03.0 ▪ Cross-key cylinder item 1.02400.10.0 ▪ Floor striker item. 1.06086.00.0 ▪ Floor striker with dust cover item 1.06086.02.0 ▪ Striking plate item 1.06232.21.0 	1	25	25	0,618	12	1	46820	25	0		
	1	25	30	0,673	12	1	46820	30	0		
	1	25	35	0,687	12	1	46820	35	0		
	1	25	25	0,550	12	1	46823	25	0		
	1	25	30	0,570	12	1	46823	30	0		
	1	25	35	0,590	12	1	46823	35	0		
	 <ul style="list-style-type: none"> ▪ Nickel-plated dead-bolt ▪ Cross-key cylinder with 3 keys ▪ Pre-arranged for additional locking points with threaded bushings M8 ▪ Pair of nylon roses item 1.06002.00.0 <p>ON REQUEST:</p> <ul style="list-style-type: none"> ▪ Extended bolts item 1.07088.03.0 ▪ Floor striker item 1.06086.00.0 ▪ Floor striker with dust cover item 1.06086.02.0 ▪ Striking plate item 1.06232.21.0 	1	85	25	0,670	12	1	46822	25	0	
		1	85	25	0,690	12	1	46822	30	0	
		1	85	25	0,710	12	1	46822	35	0	
		1	85	25	0,710	12	1	46822	35	0	

INCREASE YOUR SECURITY







CISA recommends using cylinders that provide high resistance to tearing, bumping and drilling in addition to key duplication protection (keys can only be duplicated by CISA or CISA authorized centres).

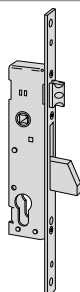

CYLINDER LOCKS FOR SECURITY GRATES

for metal frames

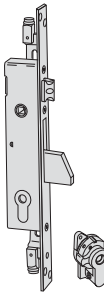
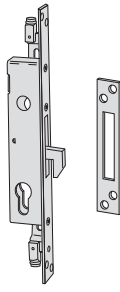

TYPE	DESCRIPTION	Throws	Centre distance	Faceplate	Backset			ITEM			
						UNIT WEIGHT	NO. PIECES	Type	Dim.	Hand	Fin.
 <ul style="list-style-type: none"> Nickel-plated dead-bolt and latch, 11 to 17 mm adjustable reversible latch Pair of steel roses item 1.06092.00.0 <p>ON REQUEST:</p> <ul style="list-style-type: none"> Striking plate item 1.06232.20.0 Cross-key cylinder item 1.02400.10.0 	1	85	25	25	0,630	12	1 46815	25	0		
	1	85	25	30	0,650	12	1 46815	30	0		
	1	85	25	35	0,670	12	1 46815	35	0		
 <ul style="list-style-type: none"> Nickel-plated dead-bolt and latch, 11 to 17 mm adjustable reversible latch Pair of steel roses item 1.06092.00.0 Pre-arranged for additional locking points with threaded bushings M8 <p>ON REQUEST:</p> <ul style="list-style-type: none"> Extended bolts item 1.07088.03.0 Cross-key cylinder item 1.02400.10.0 Floor striker item 1.06086.00.0 Floor striker with dust cover item 1.06086.02.0 Striking plate item 1.06232.20.0 	1	85	25	25	0,650	12	1 46825	25	0		
	1	85	25	30	0,670	12	1 46825	30	0		
	1	85	25	35	0,690	12	1 46825	35	0		
 <ul style="list-style-type: none"> Nickel-plated dead-bolt and latch, 11 to 17 mm adjustable reversible latch Cross-key cylinder with 3 keys Pair of nylon roses item 1.06002.00.0 Pre-arranged for additional locking points with threaded bushings M8 <p>ON REQUEST:</p> <ul style="list-style-type: none"> Extended bolts item 1.07088.03.0 Floor striker item 1.06086.00.0 Floor striker with dust cover item 1.06086.02.0 Striking plate item 1.06232.20.0 	1	85	25	25	0,770	12	1 46827	25	0		
	1	85	25	30	0,790	12	1 46827	30	0		
	1	85	25	35	0,810	12	1 46827	35	0		
 <ul style="list-style-type: none"> Nickel-plated laminated steel hook bolt, 7,5 mm Inside steel escutcheon item 1.06092.00.0 Pre-arranged for additional locking points with threaded bushings M8 Striking plate item 1.06232.21.0 <p>ON REQUEST:</p> <ul style="list-style-type: none"> Extended bolts item 1.07088.03.0 Cross-key cylinder item 1.02400.10.0 Floor striker item 1.06086.00.0 Floor striker with dust cover item 1.06086.02. 	1	85	25	25	0,610	12	1 46860	25	0		
	1	85	25	30	0,630	12	1 46860	30	0		
	1	85	25	35	0,650	12	1 46860	35	0		
 <ul style="list-style-type: none"> Top and bottom locking Inside steel escutcheon item 1.06092.00.0 Pre-arranged for additional locking points with threaded bushings M8 <p>ON REQUEST:</p> <ul style="list-style-type: none"> Extended bolts item 1.07088.03.0 Cross-key cylinder item 1.02400.10.0 Floor striker item 1.06086.00.0 Floor striker with dust cover item 1.06086.02.0 	1	85	25	25	0,530	12	1 46870	25	0		
	1	85	25	30	0,550	12	1 46870	30	0		
	1	85	25	35	0,570	12	1 46870	35	0		

About Allegion™

Allegion (NYSE: ALLE) is a global pioneer in safety and security, with leading brands like CISA®, Interflex®, LCN®, Schlage® and Von Duprin®. Focusing on security around the door and adjacent areas, Allegion produces a range of solutions for homes, businesses, schools and other institutions. Allegion is a \$2 billion company, with products sold in almost 130 countries.

For more, visit allegion.com

